

Building Enclosure Repairs - 4 Buildings

Mott High School, Kettering High School, Crary Campus, Kingsley Montgomery School

Waterford, Michigan

ENGINEER

SME
43980 PLYMOUTH OAKS BLVD.
PLYMOUTH, MI 48170
(734) 454-9900
CONTACT: MR. KYLE DAMEROW, PE

APPLICABLE CODES

2015 MICHIGAN REHABILITATION BUILDING CODE

OWNER

WATERFORD SCHOOL DISTRICT
501 NORTH CASS LAKE ROAD.
WATERFORD, MI 48328
CONTACT: MR. SIDNEY TIPPETT
(248) 613-4426

SHEET NO.	SHEET TITLE
CS1	COVER SHEET
A1.1	MOTT HIGH SCHOOL ENCLOSURE REPAIR PLAN
A1.2	MOTT HIGH SCHOOL ENCLOSURE REPAIR CONDITIONS
A1.3	MOTT HIGH SCHOOL SEALANT REPAIR PLAN
A1.4	MOTT HIGH SCHOOL SEALANT REPAIR CONDITIONS
A1.5	MOTT HIGH SCHOOL FLASHING HEIGHT ADJUSTMENT PLAN
A2.1	KETTERING HIGH SCHOOL ENCLOSURE REPAIR PLAN
A2.2	KETTERING HIGH SCHOOL ENCLOSURE REPAIR CONDITIONS
A2.3	KETTERING HIGH SCHOOL FLASHING HEIGHT ADJUSTMENT PLAN
A3.1	CRARY CAMPUS ENCLOSURE REPAIR PLAN
A3.2	CRARY CAMPUS SEALANT REPAIR PLAN
A3.3	CRARY CAMPUS ENCLOSURE AND SEALANT REPAIR CONDITIONS
A4.1	KINGSLEY MONTGOMERY SCHOOL SEALANT REPAIR PLAN
A4.2	KINGSLEY MONTGOMERY SCHOOL SEALANT REPAIR CONDITIONS
A5.1	DETAILS
A5.2	DETAILS



DRAWING NOTE: SCALE DEPICTED IS MEANT FOR 24" X 36" AND WILL SCALE INCORRECTLY IF PRINTED ON ANY OTHER SIZE MEDIA

Project
WATERFORD SCHOOL DISTRICT BUILDING ENCLOSURE REPAIRS - 4 BUILDINGS

Project Location
WATERFORD TWP, MI

Sheet Name
COVER SHEET

Engineer's Seal

REV	ISSUED FOR	DATE	BY
	OWNER REVIEW	12/22/23	AJC
	BID	1/16/24	KMD

SME Project No.
091744.00

Project Manager:
KD

Designer:
KD

CADD:
TM

Checked By:
AC

Reviewed By:
JT

Sheet No.
CS1

NO REPRODUCTION SHALL BE MADE WITHOUT THE PRIOR CONSENT OF SME ©2022



MOTT HIGH SCHOOL
1151 SCOTT LAKE RD, WATERFORD TWP, MI 48328

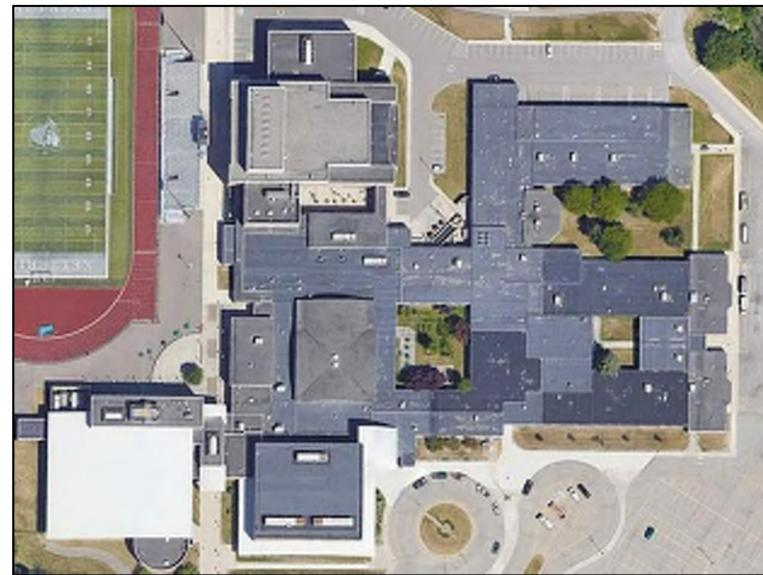

KETTERING HIGH SCHOOL
2800 KETTERING DR, WATERFORD TWP, MI 48329



CRARY CAMPUS
501 N CASS LAKE RD, WATERFORD TWP, MI 48328



KINGSLEY MONTGOMERY SCHOOL
4265 HALKIRK DR, WATERFORD TWP, MI 48329

GENERAL NOTES:

1. THE SUMMARY OF WORK CONTAINED IN THESE NOTES AND SHOWN ON THE PLANS MAY NOT INCLUDE ALL ITEMS AND ACTIVITIES NECESSARY TO COMPLETE WORK REQUIRED FOR THE REPAIRS. TAKE REASONABLE MEASURES TO PROVIDE THE DESIRED WORK RESULT, IN ADDITION TO THE REQUIREMENTS SHOWN IN THE DRAWINGS, TO COMPLETE THE WORK AT NO ADDITIONAL COST TO THE OWNER.
2. ASSUME SOLE AND COMPLETE RESPONSIBILITY FOR JOB SITE CONDITIONS, INCLUDING SAFETY AND PROTECTION OF PROPERTY AND PEDESTRIANS. PROVIDE AND MAINTAIN SAFETY DEVICES IN COMPLIANCE WITH LOCAL, STATE, AND FEDERAL SAFETY AND HEALTH STANDARDS, LAWS, AND REGULATIONS.
3. PROVIDE TEMPORARY PROTECTION, BARRICADES, TEMPORARY STRUCTURES AND OTHER MEASURES NEEDED TO PROTECT THE PEDESTRIAN AND VEHICULAR TRAFFIC ADJACENT TO AND IN THE VICINITY OF THE WORK AREA.
4. PROVIDE TEMPORARY PROTECTION WATERPROOFING, TIE-INS, WATER BLOCKS, AND INTERIOR PROTECTION NEEDED DURING THE WORK TO PREVENT LEAKS INTO THE BUILDING AND WATER DAMAGE TO THE INTERIOR. PROVIDE TARPULINS OR PLASTIC SHEETING FOR TEMPORARY PROTECTION INSIDE THE BUILDING DURING CONSTRUCTION.
5. PROVIDE TEMPORARY PROTECTION OF EXISTING EQUIPMENT, BUILDING, AND SITE DURING THE WORK, SATISFYING OWNER'S REQUIREMENTS. RESTORE EXISTING EQUIPMENT, BUILDING COMPONENTS, SIDEWALK, AND GROUNDS DAMAGED DURING THE WORK TO ORIGINAL CONDITION OR REPLACE WITH NEW MATERIALS AS DIRECTED BY THE OWNER. DAMAGED EQUIPMENT / COMPONENTS WILL BE REPLACED AT NO COST TO THE OWNER.
6. PROVIDE TEMPORARY PROTECTION OF SIDEWALKS OR OTHER PAVEMENTS AGAINST BREAKAGE DUE TO MANLIFT USE OR OTHER EQUIPMENT. RESTORE DAMAGED SIDEWALKS AND PAVEMENTS TO PRE-PROJECT CONDITIONS.
7. NOTIFY THE OWNER AND ENGINEER OF ANTICIPATED CHANGES OR ADDITIONS TO THE WORK PRIOR TO THE START OF ACTIVITIES. THE GENERAL REPAIR LIMITS ARE NOTED ON THE PROJECT DRAWINGS WITH WORK BOUNDARIES TO BE DETERMINED IN THE FIELD BY THE CONTRACTOR AND APPROVED BY THE ENGINEER.
8. PROMPTLY REPORT UNANTICIPATED CONDITIONS UNCOVERED THAT ARE CONTRARY TO THE DRAWINGS OR WILL ADVERSELY IMPACT THE WORK TO THE OWNER AND ENGINEER FOR ADVISEMENT.
9. MAINTAIN AN UP-TO-DATE SET OF PROJECT DOCUMENTS AT THE JOB SITE. KEEP ACCURATE AND LEGIBLE RECORDS OF CHANGES TO THE WORK THAT OCCUR DURING CONSTRUCTION AND INFORMATION ON 'AS-BUILT' EXISTING OR CONSTRUCTED CONDITIONS. KEEP RECORDS OF CHANGES AND AS-BUILT CONDITIONS DOCUMENTED ON A SET OF DRAWINGS TO BE PROVIDED TO THE ENGINEER AT CONSTRUCTION COMPLETION.
10. FOLLOW MANUFACTURER'S RECOMMENDATIONS FOR DELIVERY, STORAGE, MIXING, SURFACE PREPARATION, APPLICATION AND CURING OF MATERIALS USED FOR RESTORATION WORK.
11. SECURE SITE STAGING AREA FOR STORAGE TO BE COORDINATED WITH OWNER PRIOR TO BEGINNING WORK.
12. STORAGE OF MATERIALS INSIDE THE BUILDING IS PROHIBITED. DO NOT STORE FLAMMABLE MATERIALS ON THE ROOFS OR IN THE STAGING AREA. REMOVE FLAMMABLE MATERIALS FROM THE SITE AND SECURELY STORE THEM AT THE END OF EACH WORK DAY.
13. TAKE DUE CARE AND CAUTION TO AVOID TRACKING DUST, DEBRIS, OR LOOSE MATERIALS TO AREAS OUTSIDE OF THE CONSTRUCTION ZONE. REMOVE MATERIALS TRACKED TO AREAS OUTSIDE OF THE CONSTRUCTION ZONE AS SOON AS POSSIBLE, AT NO ADDITIONAL COST TO THE OWNER. CONDUCT AN INSPECTION OF THE PROJECT AREA AT THE END OF EACH WORK DAY AND TAKE STEPS TO ENSURE THE ENTIRE WORK AREA IS CLEAN. THIS REQUIREMENT INCLUDES DEBRIS FROM THE CONTRACTOR'S EMPLOYEES EATING LUNCH OR ON BREAKS.
14. REMOVE WASTE MATERIALS AND DEBRIS RESULTING FROM THE REPAIR WORK FROM THE SITE AND DISPOSE OF IN A LEGAL MANNER.
15. REMOVE STAINING / CONTAMINANTS FROM BUILDINGS SURFACES AND THE GROUNDS, INCLUDING SPILLED OR SMEARED SEALANTS, BITUMINOUS MATERIALS, GASOLINE / FUEL SPILLS, AND HYDRAULIC LEAKAGE FROM THE EQUIPMENT USED ON SITE.
16. CLEAN AND RESTORE DISTURBED GREENBELT AREAS WITH TOPSOIL, HYDROSEED, AND HIGH VELOCITY MULCH BLANKETS. LEGALLY DISPOSE OF DEBRIS OFF SITE AT AN APPROVED DISPOSAL LOCATION.
17. UPON COMPLETION OF THE WORK, CLEAR THE ENTIRE SITE OF EQUIPMENT, UNUSED MATERIALS, AND RUBBISH. RESTORE DISTURBED AREAS TO THE SATISFACTION OF THE OWNER.

Mar 02, 2025, 10:51am - cecilia.jordany
 FILE LOCATION: Z:\Materials\CAD\Templates\Drawings\SME\24-28\WAT-TEMP-LATE-SHEETS-2428.dwg
 PLOT DATE:

DRAWING NOTE: SCALE DEPICTED IS MEANT FOR 24" X 36" AND WILL SCALE INCORRECTLY IF PRINTED ON ANY OTHER SIZE MEDIA

Project
WATERFORD SCHOOL DISTRICT BUILDING ENCLOSURE REPAIRS - 4 BUILDINGS

Project Location
WATERFORD TWP, MI

Sheet Name
MOTT HIGH SCHOOL ENCLOSURE REPAIR PLAN

Engineer's Seal

Revisions

REV	ISSUED FOR	DATE	BY
	OWNER REVIEW	12/22/23	AKC
	BID	1/16/24	KMD

SME Project No.
091744.00

Project Manager:
KD

Designer:
KD

CADD:
TM

Checked By:
AC

Reviewed By:
JT

Sheet No.

A1.1

ENCLOSURE REPAIR KEYNOTES				
NO.	SYMBOL	NOTE	PHOTO REFERENCE	DETAIL
401	---	MASONRY CRACK REPAIR	M16/A1.2	401/A5.1
405A		REMOVE DETERIORATED MORTAR AND REPOINT	M12/A1.2	405A/A5.1
405B		GRIND EXPOSED HORIZONTAL REINFORCING CLEAN AND REPOINT	M7/A1.2 M8/A1.2	405B/A5.1
405C		REMOVE AND REPLACE EXISTING COPPER THROUGH WALL FLASHING*	M1-M6/A1.2	405C/A5.1
405D		COPING FLASHING REPAIR	M14/A1.2 M15/A1.2	405D/A5.1
421	---	REPLACE MISSING BRICK(S) AT NOTED LOCATIONS	M12/A1.2	421/A5.1
724A	---	PATCH DETERIORATED CANOPY AND RECOAT TO MATCH EXISTING	M10/A1.2	724A/A5.2
742	---	ROUT AND SEAL CRACKS AT FIBERBOARD PANELS ABOVE ENTRANCES	M11/A1.2	742/A5.1
996		INSTALL ELASTOMERIC COATING**	M9/A1.2 M15/A1.2	---
INV		MASONRY INVESTIGATION: PROVIDE EXPLORATORY OPENINGS FOR ENGINEER'S REVIEW	M17 - M19/A1.2	---

*REFER TO SHEET A1.5 FOR LOCATIONS REQUIRING THROUGH WALL FLASHING TO BE RAISED
 **REFER TO SPECIFICATION SECTION 099653 FOR ELASTOMERIC COATING INSTALLATION

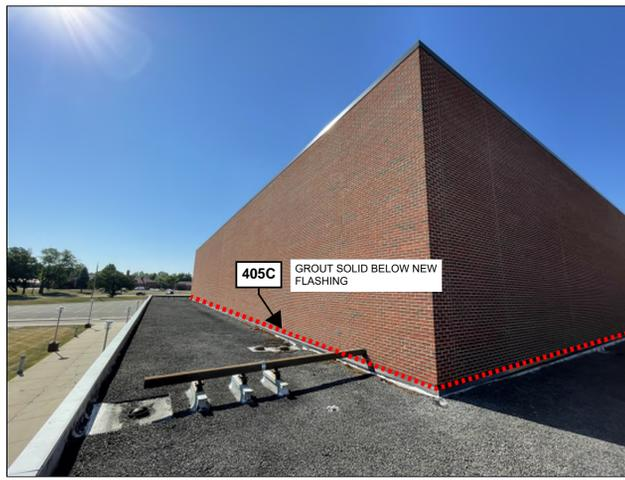
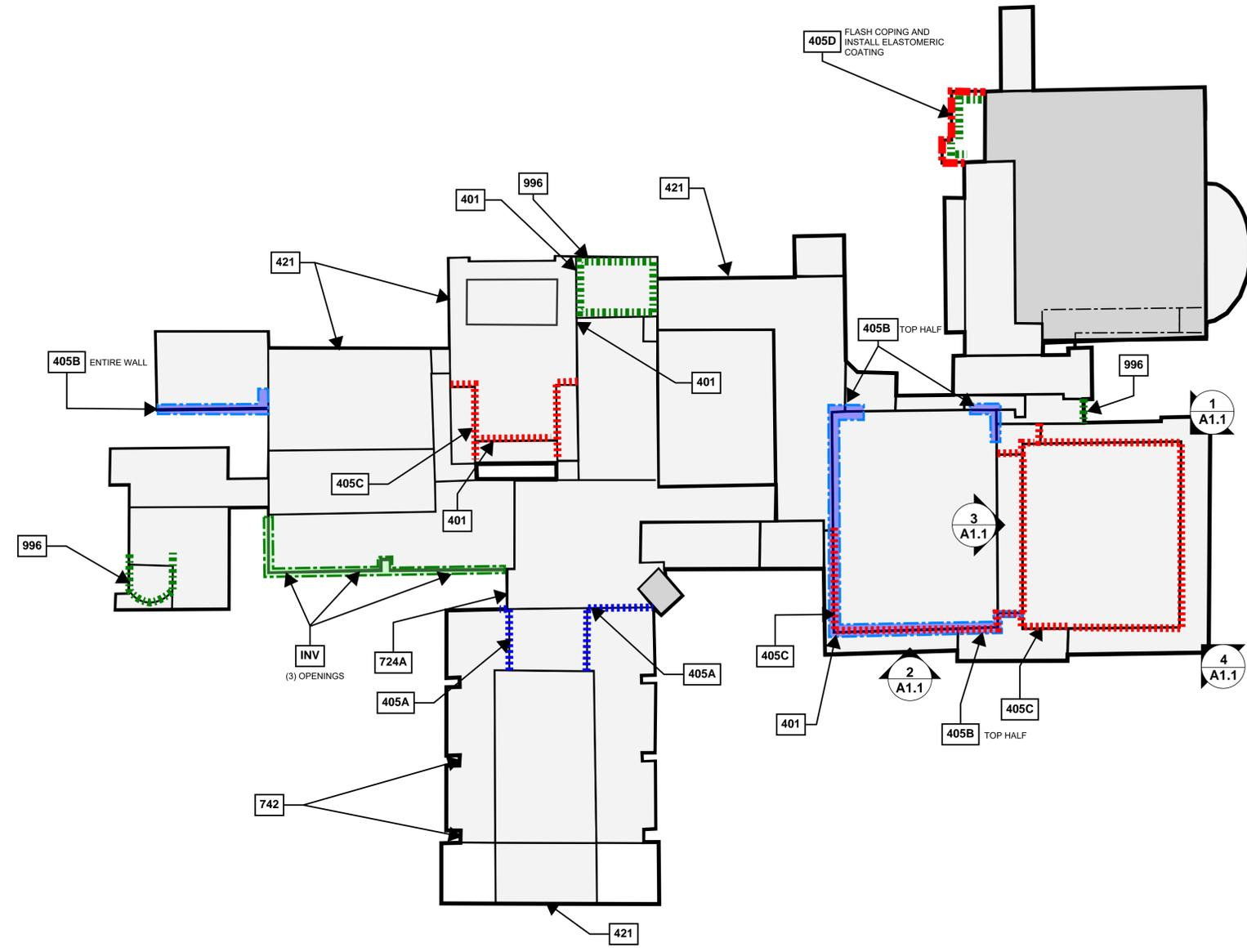

1 A1.1 NORTH GYMNASIUM NORTH AND WEST ELEVATIONS FLASHING REPAIR

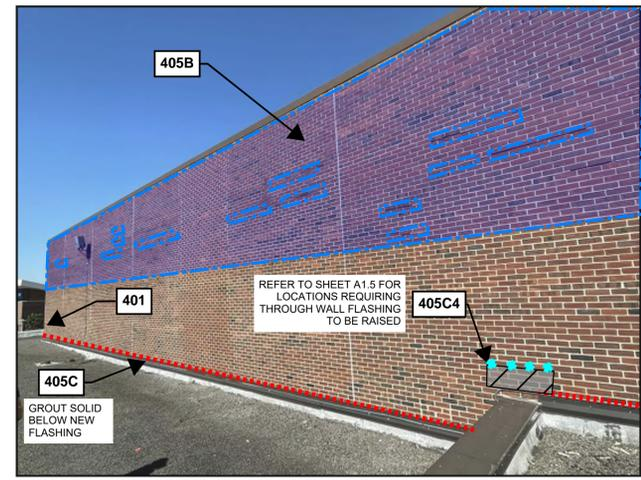

2 A1.1 SOUTH GYMNASIUM EAST ELEVATION FLASHING REPAIR

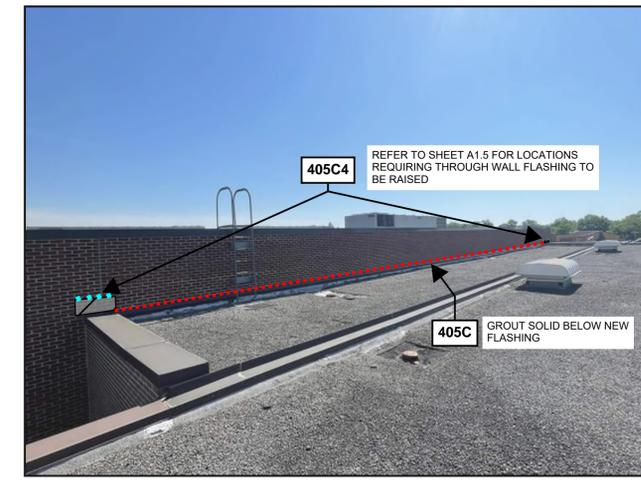

3 A1.1 NORTH GYMNASIUM SOUTH ELEVATION FLASHING REPAIR



4 A1.1 NORTH GYMNASIUM NORTH AND EAST ELEVATIONS FLASHING REPAIR

DRAWING NOTE: SCALE DEPICTED IS MEANT FOR 24" X 36" AND WILL SCALE INCORRECTLY IF PRINTED ON ANY OTHER SIZE MEDIA

Project
**WATERFORD SCHOOL DISTRICT
BUILDING ENCLOSURE
REPAIRS - 4 BUILDINGS**

Project Location
WATERFORD TWP, MI

Sheet Name
**MOTT HIGH SCHOOL
ENCLOSURE REPAIR
CONDITIONS**

Engineer's Seal

Revisions

REV	ISSUED FOR	DATE	BY
	OWNER REVIEW	12/22/23	AKC
	BID	1/16/24	KMD

SME Project No.
091744.00

Project Manager:
KD

Designer:
KD

CADD:
TM

Checked By:
AC

Reviewed By:
JT

Sheet No.

A1.2



M1 ITEM 405C - FLASHING REPAIRS - PERFORMING ARTS CENTER



M2 ITEM 405C - FLASHING REPAIRS - PERFORMING ARTS CENTER



M3 ITEM 405C - FLASHING REPAIRS - SOUTH GYMNASIUM EAST ELEVATION



M1 ITEM 405C - FLASHING REPAIRS - SOUTH GYMNASIUM EAST ELEVATION



M4 ITEM 405C - FLASHING REPAIRS - NORTH GYMNASIUM SOUTH ELEVATION



M5 ITEM 405C - FLASHING REPAIRS - NORTH GYMNASIUM SOUTH ELEVATION



M6 ITEM 405C - FLASHING REPAIRS - NORTH GYMNASIUM EAST ELEVATION



M7 ITEM 405B - HORIZONTAL JOINT REINFORCEMENT REPAIRS



M8 ITEM 405B - HORIZONTAL JOINT REINFORCEMENT REPAIRS



M9 ITEM 996 - CMU ELASTOMERIC COATING REPAIRS



M10 ITEM 724A - CANOPY PATCH REPAIRS



M11 ITEM 742 - CANOPY REPAIRS - ROUTE AND SEAL CRACKED FIBERBOARD



M12 ITEM 421 - BRICK REPLACEMENT



M13 ITEM 405A - BRICK REPOINTING AT PARAPET

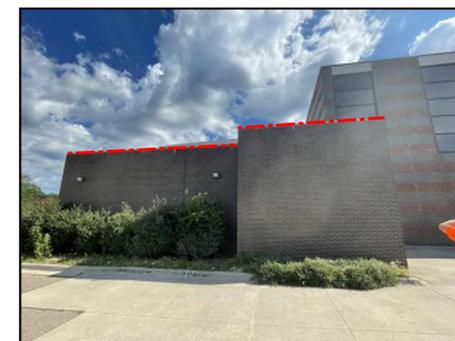

M14 ITEM 405D - COPING FLASHING AND ELASTOMERIC COATING REPAIRS



M15 ITEM 405D & 996 - COPING FLASHING AND ELASTOMERIC COATING REPAIRS

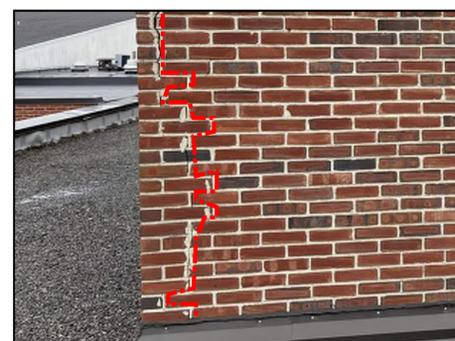

M16 ITEM 401 - MASONRY CRACK REPAIR



M17 ITEM INV - PROPOSED EXPLORATORY OPENING LOCATION NO. 1



M18 ITEM INV - PROPOSED EXPLORATORY OPENING LOCATION NO. 2



M19 ITEM INV - PROPOSED EXPLORATORY OPENING LOCATION NO. 3

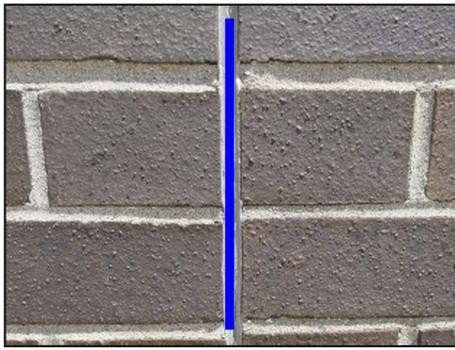

M20 ITEM 795 - SEALANT REPLACEMENT AT BRICK EXPANSION JOINT

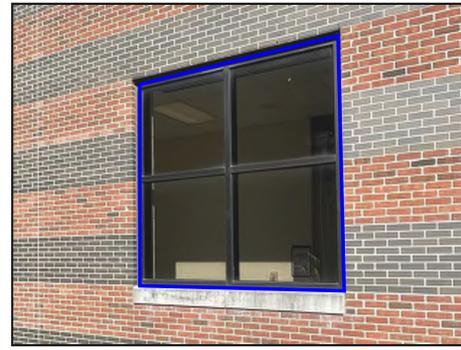

M21 ITEM 792D - SEALANT REPLACEMENT AROUND OPENINGS - WINDOWS



M22 ITEM 792D - SEALANT REPLACEMENT AROUND OPENINGS - DOORS



M23 ITEM 792C - SEALANT REPLACEMENT - NEEDLE GLAZING



M24 ITEM 792A - SEALANT REPLACEMENT AT DISSIMILAR MATERIALS - FIBERBOARD-TO-FRAME JOINTS

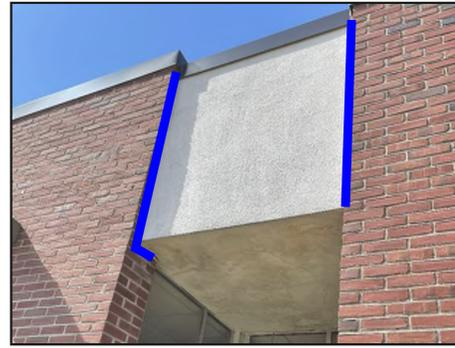

M25 ITEM 792A - SEALANT REPLACEMENT AT DISSIMILAR MATERIALS - BRICK-TO-FIBERBOARD JOINTS

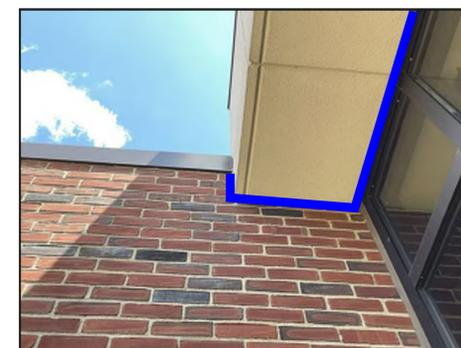

M26 ITEM 792A - SEALANT REPLACEMENT AT DISSIMILAR MATERIALS - BRICK-TO-CANOPY AND CANOPY-TO-FRAME JOINTS



M27 ITEM 792B - SEALANT REPLACEMENT AT PRECAST WINDOWSILL JOINTS

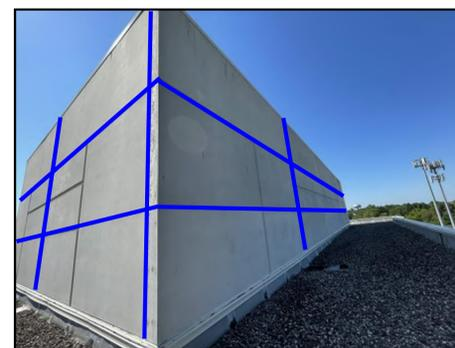

M28 ITEM 792E - SEALANT REPLACEMENT AT PRECAST PANEL JOINTS



M29 792F - SEALANT REPLACEMENT AT EIFS PANEL JOINTS

DRAWING NOTE: SCALE DEPICTED IS MEANT FOR 24" X 36" AND WILL SCALE INCORRECTLY IF PRINTED ON ANY OTHER SIZE MEDIA

Project
WATERFORD SCHOOL DISTRICT BUILDING ENCLOSURE REPAIRS - 4 BUILDINGS

Project Location
WATERFORD TWP, MI

Sheet Name
MOTT HIGH SCHOOL SEALANT REPAIR CONDITIONS

Engineer's Seal

REV	ISSUED FOR	DATE	BY
	OWNER REVIEW	12/22/23	AKC
	BID	1/16/24	KMD

SME Project No. **091744.00**

Project Manager: **KD**

Designer: **KD**

CADD: **TM**

Checked By: **AC**

Reviewed By: **JT**

Sheet No.

A1.4

DRAWING NOTE: SCALE DEPICTED IS MEANT FOR 24" X 36" AND WILL SCALE INCORRECTLY IF PRINTED ON ANY OTHER SIZE MEDIA

Project
**WATERFORD SCHOOL DISTRICT
BUILDING ENCLOSURE REPAIRS - 4 BUILDINGS**

Project Location
WATERFORD TWP, MI

Sheet Name
MOTT HIGH SCHOOL FLASHING HEIGHT ADJUSTMENT PLAN

Engineer's Seal

Revisions

REV	ISSUED FOR	DATE	BY
1	OWNER REVIEW	12/22/23	AKC
2	BID	1/16/24	KMD

SME Project No.
091744.00

Project Manager:
KD

Designer:
KD

CADD:
TM

Checked By:
AC

Reviewed By:

Sheet No.
A1.5

THROUGH WALL FLASH HEIGHT KEYNOTES				
NO.	SYMBOL	NOTE	PHOTO REFERENCE	DETAIL
405C4		DURING THROUGH WALL FLASHING REPLACEMENT RAISE FLASHING MIN. 4 COURSES ABOVE EXISTING EXISTING THROUGH WALL FLASHING HEIGHT	---	405C/A5.1
405C3		DURING THROUGH WALL FLASHING REPLACEMENT RAISE FLASHING MIN. 3 COURSES ABOVE EXISTING THORUGH WALL FLASHING/COUNTERFLASHING HEIGHT	---	405C/A5.1

REFER TO SHEET A1.1 FOR FLASHING REPAIR LOCATIONS THAT DO NOT REQUIRE THROUGH WALL FLASHINGS TO BE RAISED.

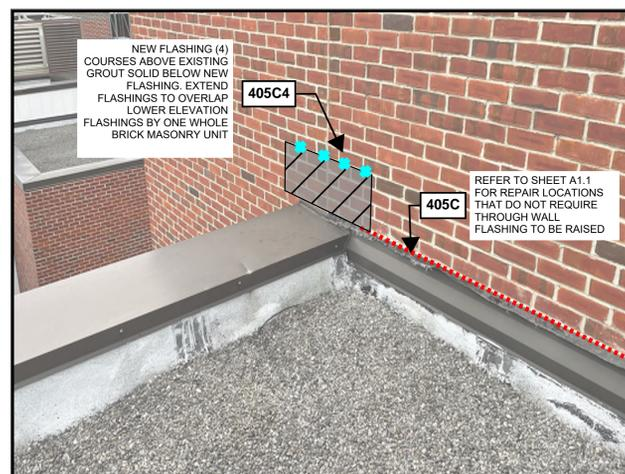
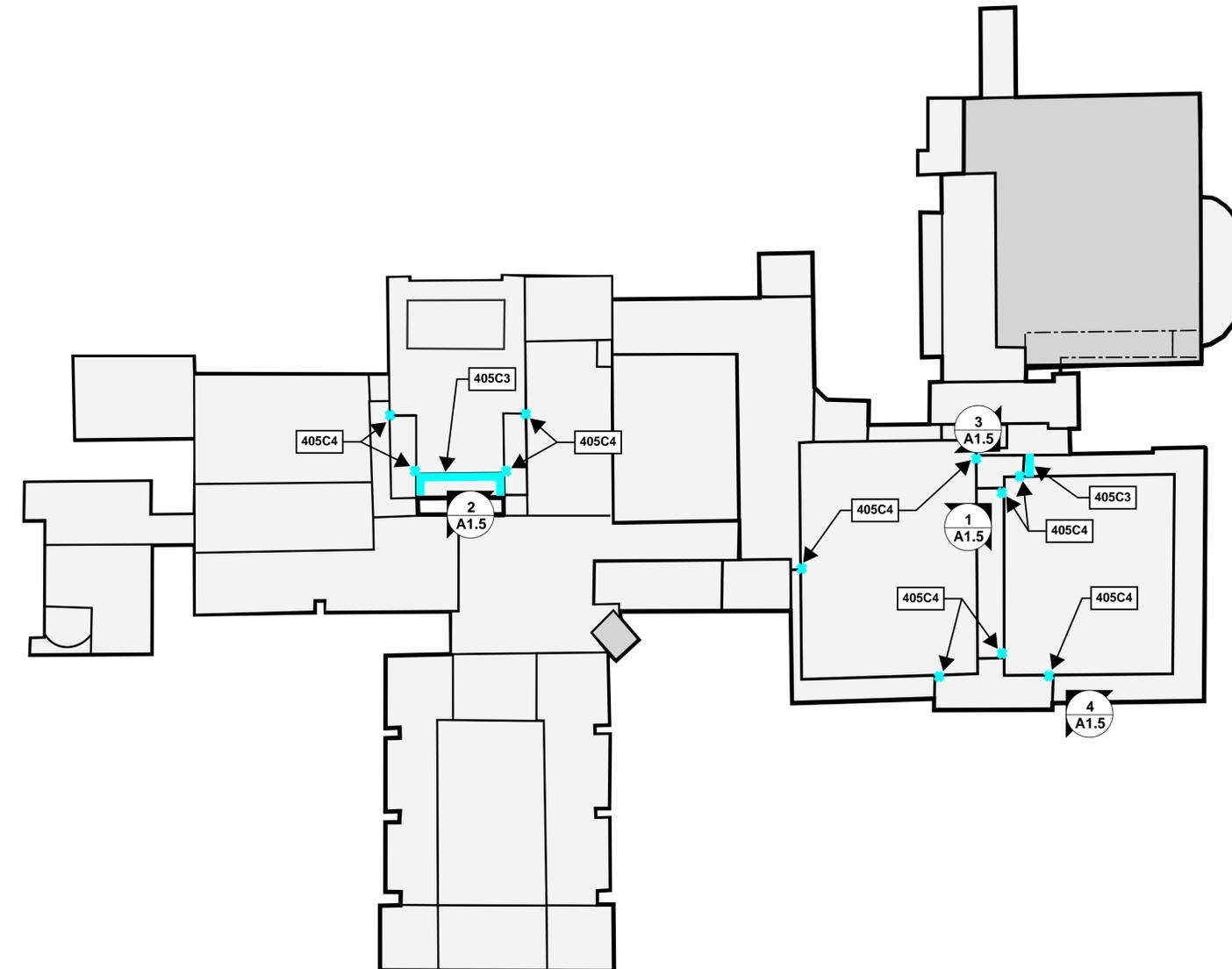

1
A1.5 **NORTH GYMNASIUM SOUTH ELEVATION FLASHING REPAIR**

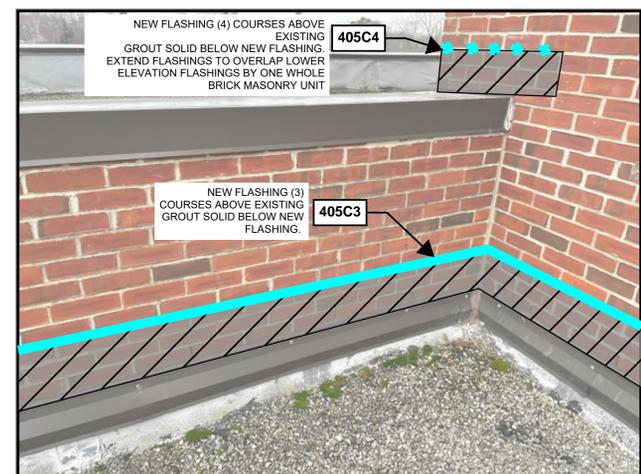

2
A1.5 **SOUTH PAC ELEVATION FLASHING REPAIR**

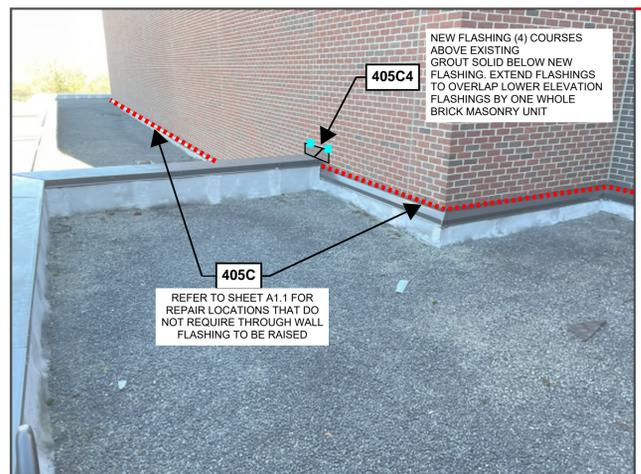

3
A1.5 **NORTH GYMNASIUM EAST ELEVATION FLASHING REPAIR**

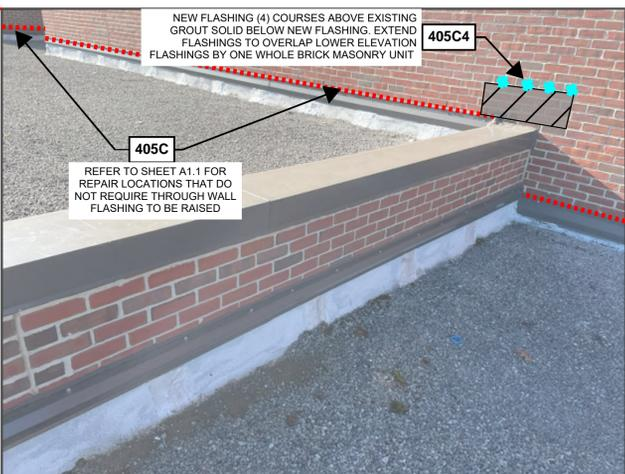

4
A1.5 **NORTH GYMNASIUM SOUTH ELEVATION FLASHING REPAIR**

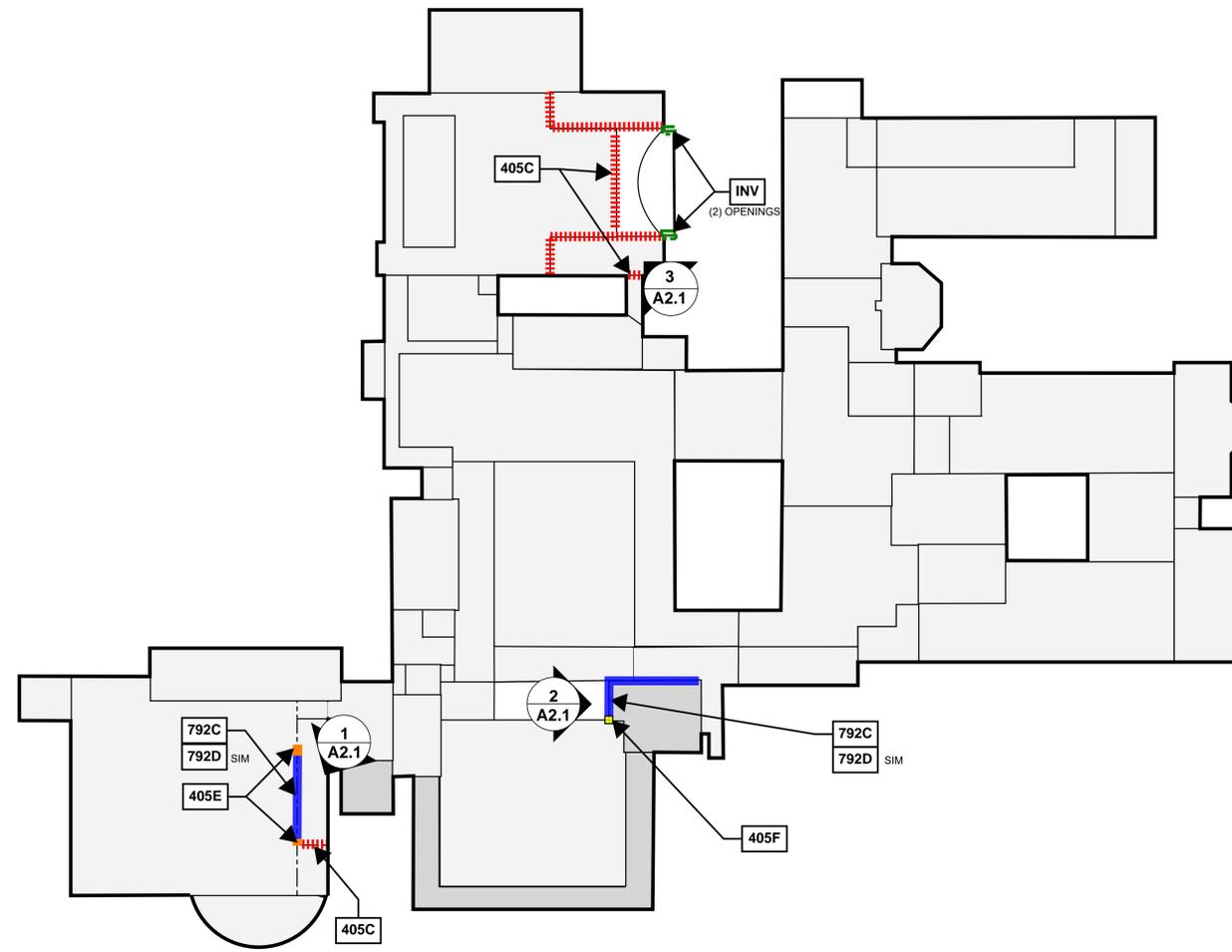

ENCLOSURE REPAIR KEYNOTES				
NO.	SYMBOL	NOTE	PHOTO REFERENCE	DETAIL
405C	Red dashed line	REMOVE AND REPLACE EXISTING COPPER THROUGH WALL FLASHING*	K1 - K3/A2.2	405C/A5.1
405E	Orange line	REPLACE END DAMS	K4, K6, K7/A2.2	405E/A5.1
405F	Yellow line	CAVITY CLOSURE REPAIR	K8 - K11/A2.2	405F/A5.2
792C	Blue line	REPLACE NEEDLE GLAZING	K6 - K9/A2.2	792C/A5.2
792D	Blue line	REPLACE SEALANTS AROUND OPENINGS	K6 - K11/A2.2	792D/A5.2
INV	Green dashed line	MASONRY INVESTIGATION: PROVIDE EXPLORATORY OPENINGS FOR CONSULTANT'S REVIEW	K12/A2.2 K13/A2.2	—

*REFER TO SHEET A2.3 FOR LOCATIONS REQUIRING THROUGH WALL FLASHING TO BE RAISED



DRAWING NOTE: SCALE DEPICTED IS MEANT FOR 24" X 36" AND WILL SCALE INCORRECTLY IF PRINTED ON ANY OTHER SIZE MEDIA

Project
**WATERFORD SCHOOL DISTRICT
BUILDING ENCLOSURE REPAIRS - 4 BUILDINGS**

Project Location
WATERFORD TWP, MI

Sheet Name
**KETTERING HIGH SCHOOL
ENCLOSURE REPAIR PLAN**

Engineer's Seal

Revisions			
REV	ISSUED FOR	DATE	BY
	OWNER REVIEW	12/22/23	AKC
	BID	1/16/24	KMD

SME Project No.
091744.00

Project Manager:
KD

Designer:
KD

CADD:
TM

Checked By:
AC

Reviewed By:
JT

Sheet No.

A2.1

NO REPRODUCTION SHALL BE MADE WITHOUT THE PRIOR CONSENT OF SME © 2023

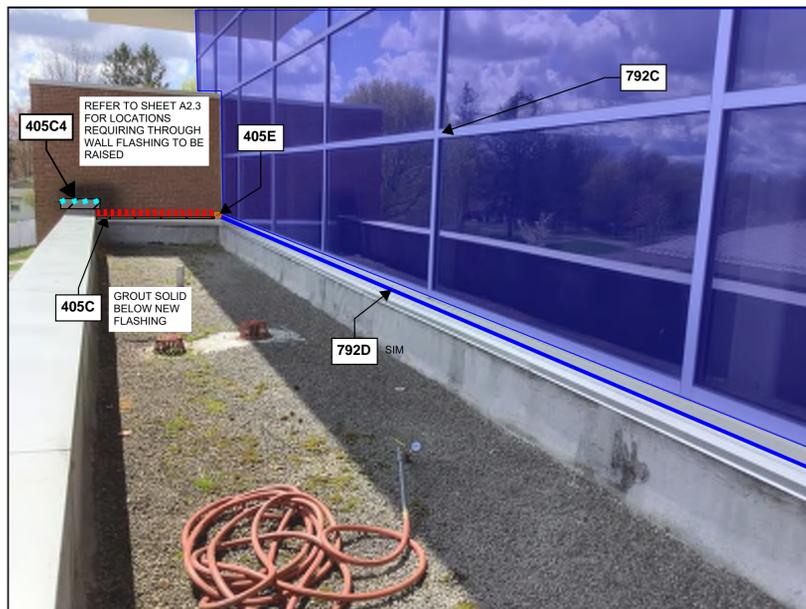

1 A2.1 NATATORIUM PARTIAL EAST ELEVATION

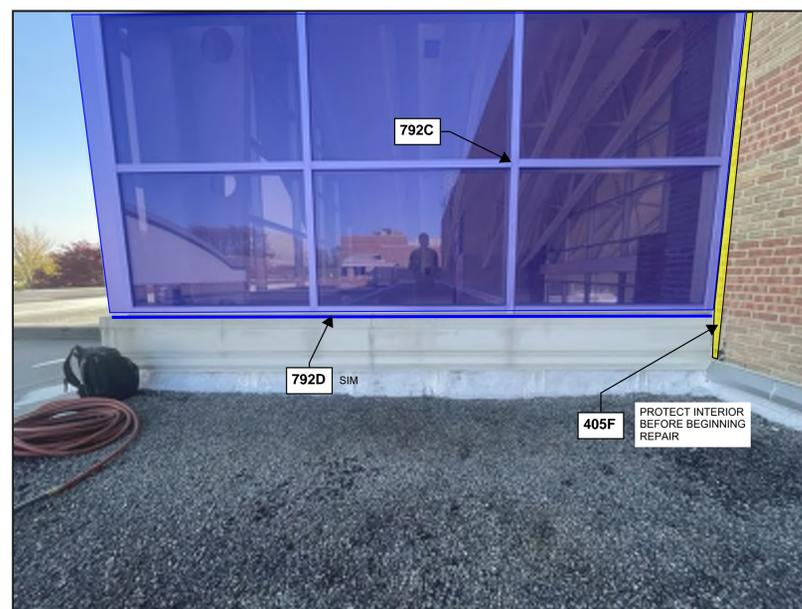

2 A2.1 SOUTH ENTRANCE CURTAIN WALL WEST ELEVATION



3 A2.1 PAC SOUTH ELEVATION FLASHING REPAIR

DRAWING NOTE: SCALE DEPICTED IS MEANT FOR 24" X 36" AND WILL SCALE INCORRECTLY IF PRINTED ON ANY OTHER SIZE MEDIA

Project
WATERFORD SCHOOL DISTRICT BUILDING ENCLOSURE REPAIRS - 4 BUILDINGS

Project Location
WATERFORD TWP, MI

Sheet Name
KETTERING HIGH SCHOOL ENCLOSURE REPAIR CONDITIONS

Engineer's Seal

Revisions

REV	ISSUED FOR	DATE	BY
	OWNER REVIEW	12/22/23	AKC
	BID	1/16/24	KMD

SME Project No.
091744.00

Project Manager:
KD

Designer:
KD

CADD:
TM

Checked By:
AC

Reviewed By:
JT

Sheet No.

A2.2



K1 ITEM 405C6 - PAC SOUTH ELEVATION FLASHING REPAIR



K2 ITEM 405C6 - PAC SOUTH ELEVATION FLASHING REPAIR



K3 ITEM 405C6 - PAC SOUTH ELEVATION FLASHING REPAIR EXISTING CONDITIONS NO. 3

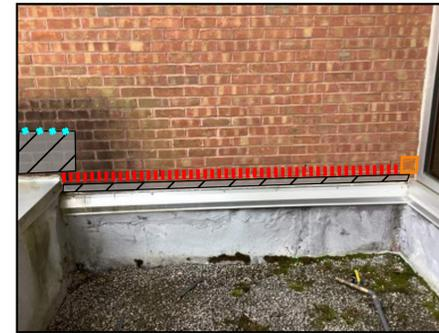

K4 ITEMS 405C, 405C4, 405E - NATATORIUM - FLASHING AND END DAM REPAIR

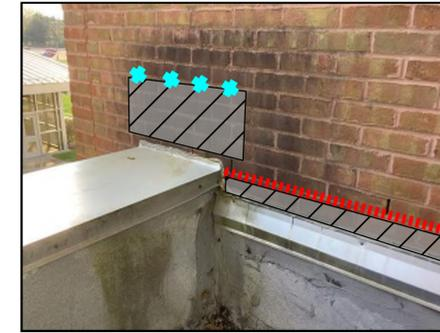

K5 ITEM 405C & 405C4 - NATATORIUM - FLASHING REPAIR



K6 ITEMS 405E, 792C, 792D - NATATORIUM SEALANT AND END DAM REPAIR - NORTH



K7 ITEMS 405E, 792C, 792D - NATATORIUM SEALANT AND END DAM REPAIR - SOUTH



K8 ITEMS 405F, 792C, 792D - SOUTH ENTRANCE CURTAIN WALL CAVITY CLOSURE AND SEALANT REPAIR



K9 ITEMS 405F, 792C, 792D - SOUTH ENTRANCE CURTAIN WALL CAVITY CLOSURE AND SEALANT REPAIR - CORNER



K10 ITEMS 405F, 792C, 792D - SOUTH ENTRANCE CURTAIN WALL CAVITY CLOSURE AND SEALANT REPAIR - INTERIOR VIEW



K11 ITEMS 405F, 792C, 792D - SOUTH ENTRANCE CURTAIN WALL INTERIOR VIEW



K12 ITEM INV - PROPOSED EXPLORATORY OPENING LOCATION PAC NORTH ELEVATION



K13 ITEM INV - PROPOSED EXPLORATORY OPENING LOCATION PAC SOUTH ELEVATION

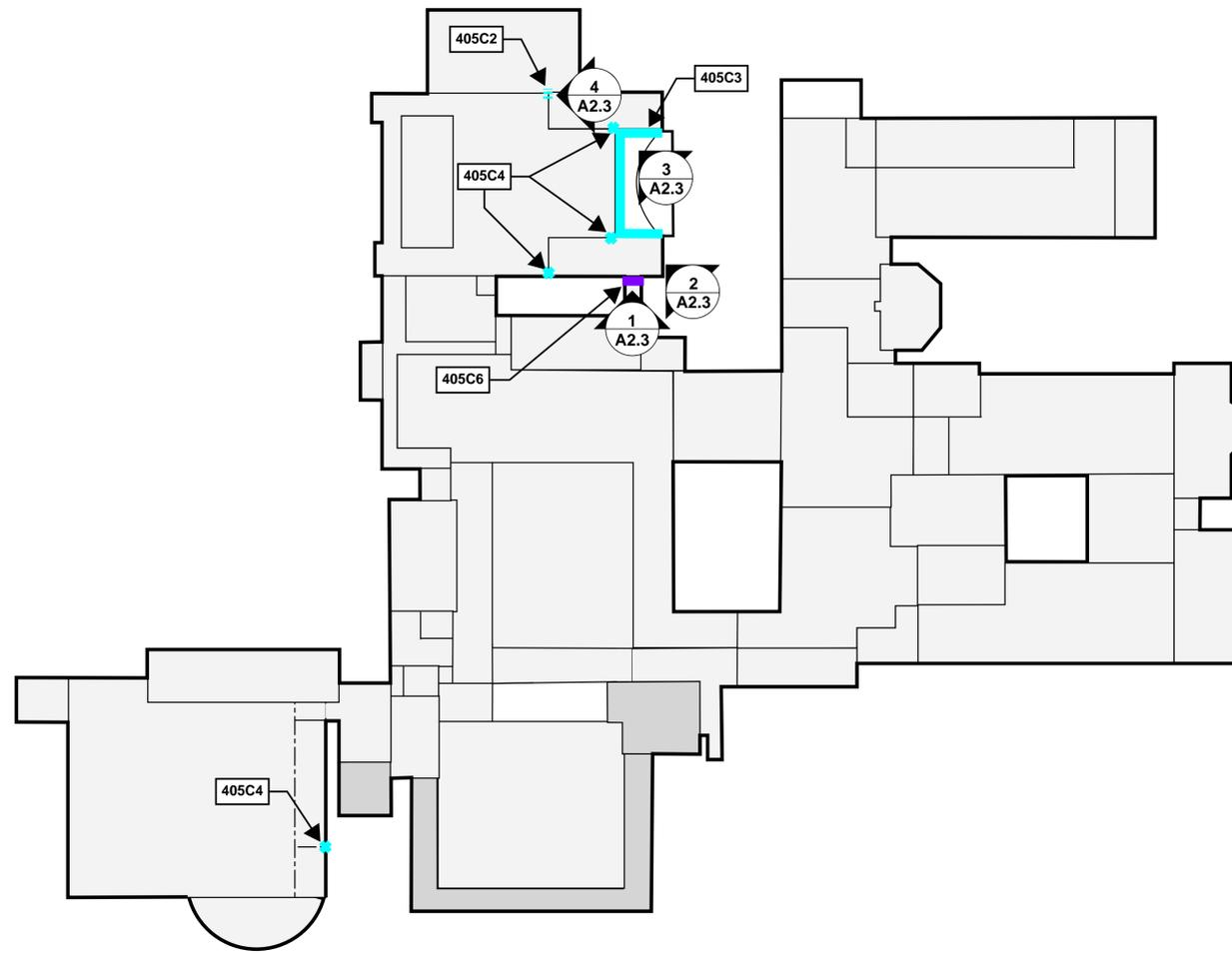

THROUGH WALL FLASH HEIGHTS KEYNOTES				
NO.	SYMBOL	NOTE	PHOTO REFERENCE	DETAIL
405C6		DURING THROUGH WALL FLASHING REPLACEMENT RAISE FLASHING MIN. 6 COURSES ABOVE EXISTING EXISTING THROUGH WALL FLASHING HEIGHT	---	405C/A5.1
405C4		DURING THROUGH WALL FLASHING REPLACEMENT RAISE FLASHING MIN. 4 COURSES ABOVE EXISTING THOROUGH WALL FLASHING HEIGHT	---	405C/A5.1
405C3		DURING THROUGH WALL FLASHING REPLACEMENT RAISE FLASHING MIN. 3 COURSES ABOVE EXISTING THOROUGH WALL FLASHING/COUNTERFLASHING HEIGHT	---	405C/A5.1
405C2		DURING THROUGH WALL FLASHING REPLACEMENT RAISE FLASHING MIN. 2 COURSES ABOVE EXISTING THROUGHWALL FLASHING HEIGHT	---	405C/A5.1

REFER TO SHEET A2.1 FOR FLASHING REPAIR LOCATIONS THAT DO NOT REQUIRE THROUGH WALL FLASHINGS TO BE RAISED.



DRAWING NOTE: SCALE DEPICTED IS MEANT FOR 24" X 36" AND WILL SCALE INCORRECTLY IF PRINTED ON ANY OTHER SIZE MEDIA

Project
WATERFORD SCHOOL DISTRICT BUILDING ENCLOSURE REPAIRS - 4 BUILDINGS

Project Location
WATERFORD TWP, MI

Sheet Name
KETTERING HIGH SCHOOL FLASHING HEIGHT ADJUSTMENT PLAN

Engineer's Seal

Revisions			
REV	ISSUED FOR	DATE	BY
	OWNER REVIEW	12/22/23	AKC
	BID	1/16/24	KMD

SME Project No.
091744.00

Project Manager:
KD

Designer:
KD

CADD:
TM

Checked By:
AC

Reviewed By:

Sheet No.

A2.3



1
A1.5 SOUTH PAC ELEVATION FLASHING REPAIR

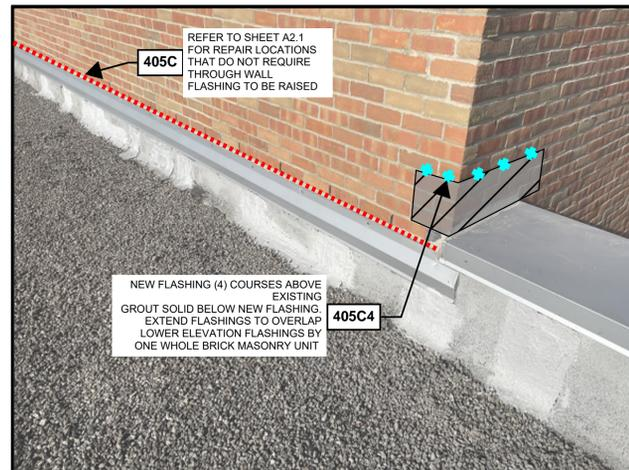

2
A1.5 SOUTH PAC ELEVATION FLASHING REPAIR

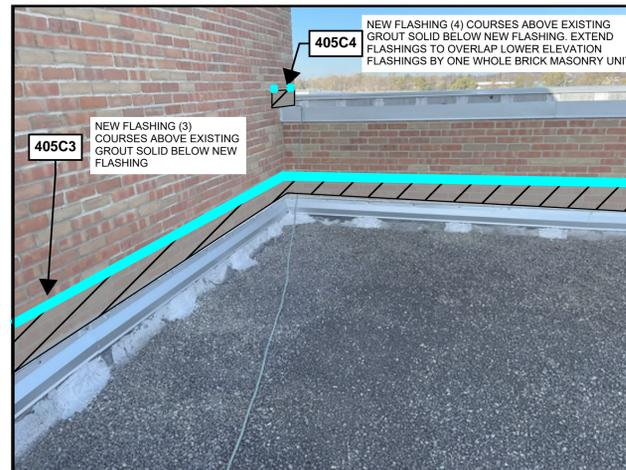

3
A1.5 SOUTH PAC ELEVATION FLASHING REPAIR

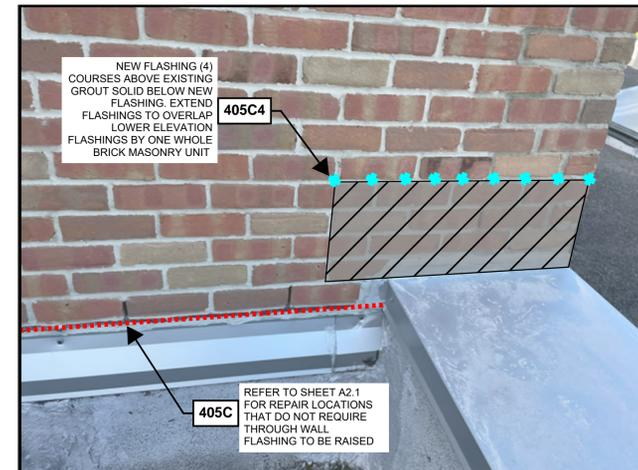

4
A1.5 NORTH PAC ELEVATION FLASHING REPAIR

DRAWING NOTE: SCALE DEPICTED IS MEANT FOR 24" X 36" AND WILL SCALE INCORRECTLY IF PRINTED ON ANY OTHER SIZE MEDIA

Project
WATERFORD SCHOOL DISTRICT BUILDING ENCLOSURE REPAIRS - 4 BUILDINGS

Project Location
WATERFORD TWP, MI

Sheet Name
CRARY CAMPUS ENCLOSURE REPAIR PLAN

Engineer's Seal

Revisions

REV	ISSUED FOR	DATE	BY
	OWNER REVIEW	12/22/23	AKC
	BID	1/16/24	KMD

SME Project No.
091744.00

Project Manager:
KD

Designer:
KD

CADD:
TM

Checked By:
AC

Reviewed By:
JT

Sheet No.

A3.1

NO REPRODUCTION SHALL BE MADE WITHOUT THE PRIOR CONSENT OF SME © 2024

ENCLOSURE REPAIR KEYNOTES				
NO.	SYMBOL	NOTE	PHOTO REFERENCE	DETAIL
405A	■■■■■■■■■■	REMOVE DETERIORATED MORTAR AND REPOINT	C4/A3.3	405A/A5.1
724B	■■■■■■■■■■	REPLACE EIFS WITH NEW WATER-MANAGED EIFS*	C1/A3.3 C2/A3.3	724B/A5.1
744	■■■■■■■■■■	AGGREGATE COATING REPAIR	C3/A3.3	744/A5.2

*REFER TO SPECIFICATION SECTION 028716.13 FOR BIRD EXCREMENT REMOVAL AT EIFS

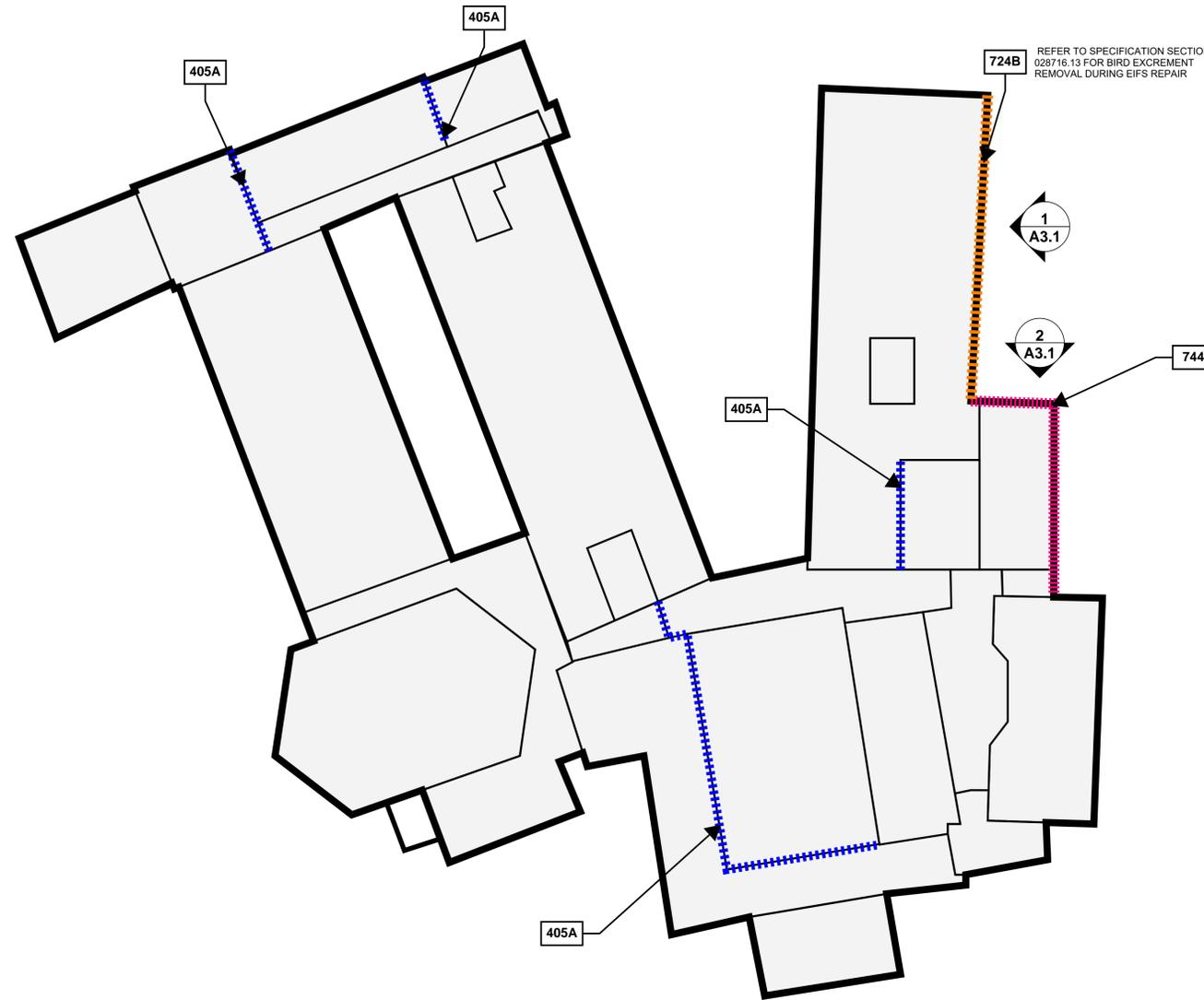

1 A3.1 PARTIAL EAST ELEVATION EIFS REPLACEMENT



2 A3.1 PARTIAL NORTH ELEVATION AGGREGATE COATING REPAIR



C1 ITEM 724B - EIFS REPLACEMENT



C2 ITEM 724B - EIFS REPLACEMENT



C3 ITEM 744 - AGGREGATE COATING REPAIR



C4 ITEM 405A - BRICK REPOINTING

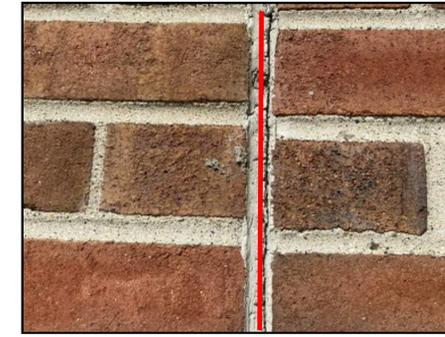

C5 ITEM 795 - EXPANSION JOINT SEALANT REPLACEMENT



C6 ITEM 792A - SEALANT REPLACEMENT AT DISSIMILAR MATERIALS - BRICK-TO-FRAME JOINTS



C7 ITEM 792A - SEALANT REPLACEMENT AT DISSIMILAR MATERIALS - BRICK-TO-SOFFIT JOINTS



C8 ITEM 792C - NEEDLE GLAZING REPLACEMENT AT NORTH COURTYARD WINDOWS



C9 ITEM 792C - NEEDLE GLAZING REPLACEMENT AT WINDOWS



C10 ITEM 792D - SEALANT REPLACEMENT AROUND OPENINGS



C11 ITEM 792D - SEALANT REPLACEMENT AROUND OPENINGS



C12 ITEM 792C - SEALANT REPLACEMENT AROUND OPENINGS - UNSEALED PENETRATION



C13 ITEM 792B - SEALANT REPLACEMENT AT PRECAST SILL JOINTS



C14 ITEM 792E - PRECAST PANEL SEALANT REPLACEMENT

DRAWING NOTE: SCALE DEPICTED IS MEANT FOR 24" X 36" AND WILL SCALE INCORRECTLY IF PRINTED ON ANY OTHER SIZE MEDIA

Project WATERFORD SCHOOL DISTRICT BUILDING ENCLOSURE REPAIRS - 4 BUILDINGS

Project Location WATERFORD TWP, MI

Sheet Name CRARY CAMPUS ENCLOSURE AND SEALANT REPAIR CONDITIONS

Engineer's Seal

Revisions table with columns: REV, ISSUED FOR, DATE, BY

SME Project No. 091744.00

Project Manager: KD

Designer: KD

CADD: TM

Checked By: AC

Reviewed By: JT

Sheet No.

DRAWING NOTE: SCALE DEPICTED IS MEANT FOR 24" X 36" AND WILL SCALE INCORRECTLY IF PRINTED ON ANY OTHER SIZE MEDIA

Project
**WATERFORD SCHOOL DISTRICT
BUILDING ENCLOSURE REPAIRS - 4 BUILDINGS**

Project Location
WATERFORD TWP, MI

Sheet Name
**KINGSLEY MONTGOMERY SCHOOL
SEALANT REPAIR PLAN**

Engineer's Seal

REV	ISSUED FOR	DATE	BY
	OWNER REVIEW	12/22/23	AKC
	BID	1/16/24	KMD

SME Project No.
091744.00

Project Manager:
KD

Designer:
KD

CADD:
TM

Checked By:
AC

Reviewed By:
JT

Sheet No.

A4.1

ENCLOSURE REPAIR KEYNOTES				
NO.	SYMBOL	NOTE	PHOTO REFERENCE	DETAIL
792A		REPLACE SEALANTS AT INTERFACE OF DISSIMILAR MATERIALS	KM4/A4.2	792A/5.2
792B		REPLACE PRECAST WINDOWSILL SEALANT	KM6/A4.2	792B/A5.2
792D		REPLACE PERIMETER AND PENETRATION SEALANTS	KM1 - KM3/A4.2	792D/A5.2
792E		REPLACE PRECAST PANEL SEALANTS	KM5/A4.2	792E/A5.2
795		REPLACE BRICK EXPANSION JOINT SEALANT	KM7/A4.2	795/A5.2

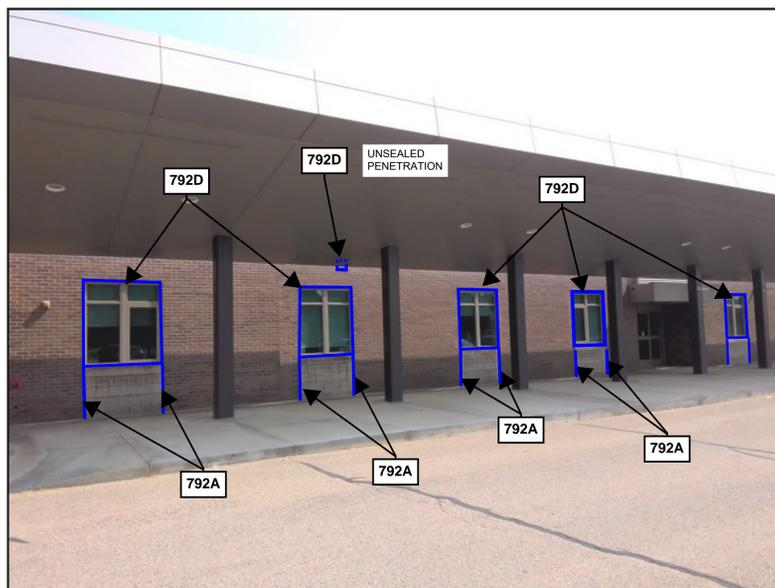
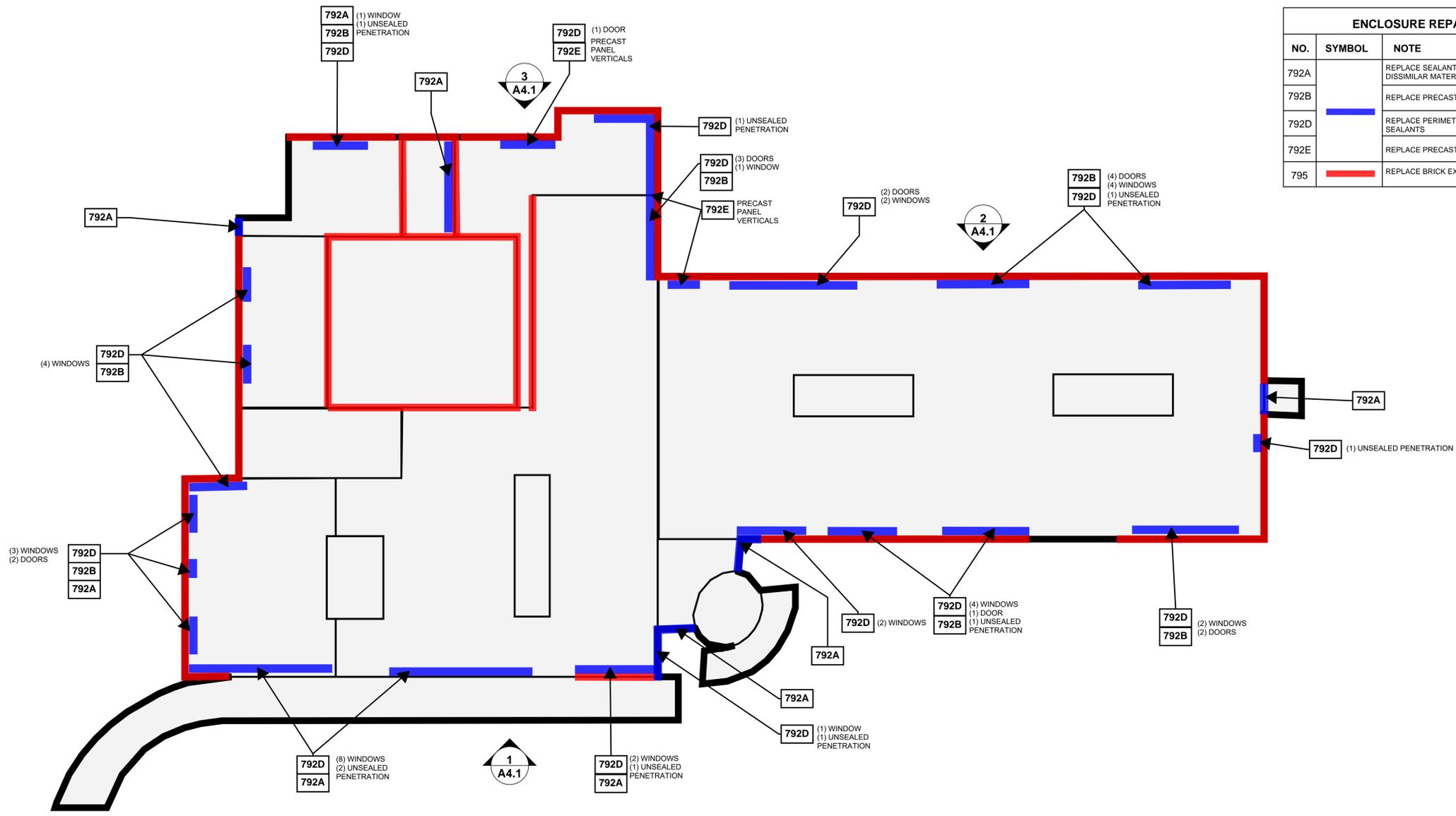

1
A4.1 **PARTIAL SOUTH ELEVATION SEALANT REPLACEMENT**

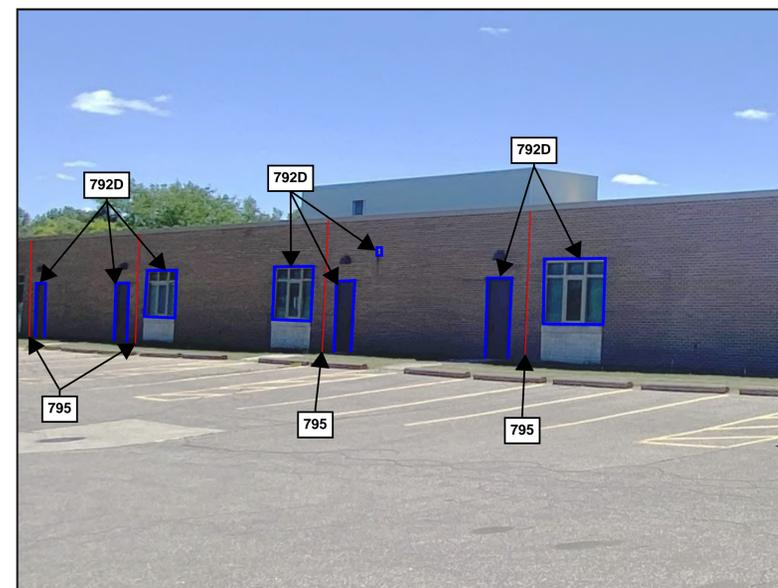

2
A4.1 **PARTIAL NORTH ELEVATION SEALANT REPLACEMENT**

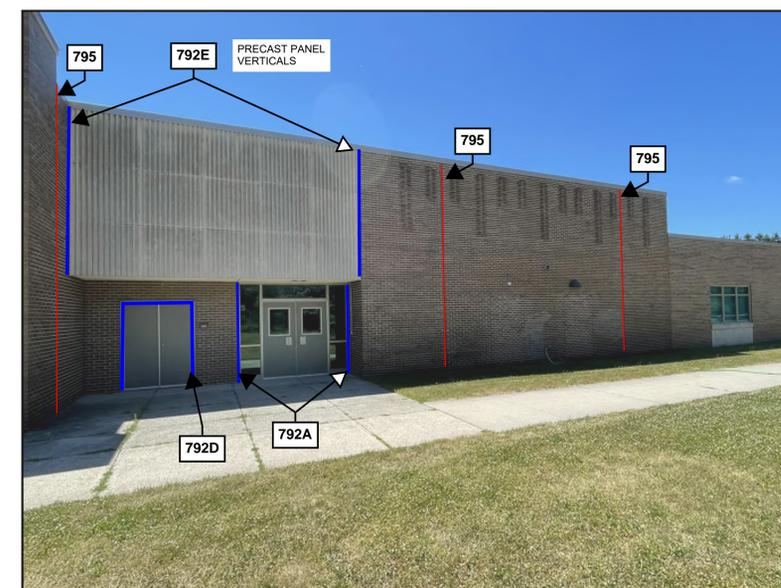

3
A4.1 **PARTIAL NORTH ELEVATION SEALANT REPLACEMENT**

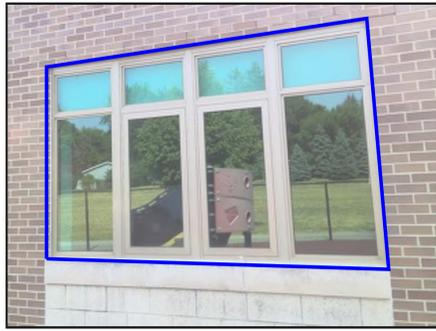

KM1 ITEM 792D - SEALANT REPLACEMENT AT WINDOW PERIMETER



KM2 ITEM 792D - SEALANT REPLACEMENT AT UNSEALED PENETRATIONS



KM3 ITEM 792D - SEALANT REPLACEMENT AT DOOR PERIMETER



KM4 ITEM 792A - SEALANT REPLACEMENT AT DISSIMILAR MATERIALS - BRICK-TO-STONE JOINTS



KM5 ITEM 792E - SEALANT REPLACEMENT AT DISSIMILAR MATERIALS - PRECAST PANEL JOINTS



KM6 ITEM 792B - SEALANT REPLACEMENT AT PRECAST SILL



KM7 ITEM 795 - SEALANT REPLACEMENT AT TYPICAL EXPANSION JOINT

DRAWING NOTE: SCALE DEPICTED IS MEANT FOR 24" X 36" AND WILL SCALE INCORRECTLY IF PRINTED ON ANY OTHER SIZE MEDIA

Project
**WATERFORD SCHOOL DISTRICT
 BUILDING ENCLOSURE REPAIRS - 4 BUILDINGS**

Project Location
WATERFORD TWP, MI

Sheet Name
**KINGSLEY MONTGOMERY
 SCHOOL SEALANT
 REPAIR CONDITIONS**

Engineer's Seal

Revisions

REV	ISSUED FOR	DATE	BY
	OWNER REVIEW	12/22/23	AKC
	BID	1/16/24	KMD

SME Project No.
091744.00

Project Manager:
KD

Designer:
KD

CADD:
TM

Checked By:
AC

Reviewed By:
JT

Sheet No.

OWNER REVIEW	12/22/23	TM
BID	1/16/24	KMD

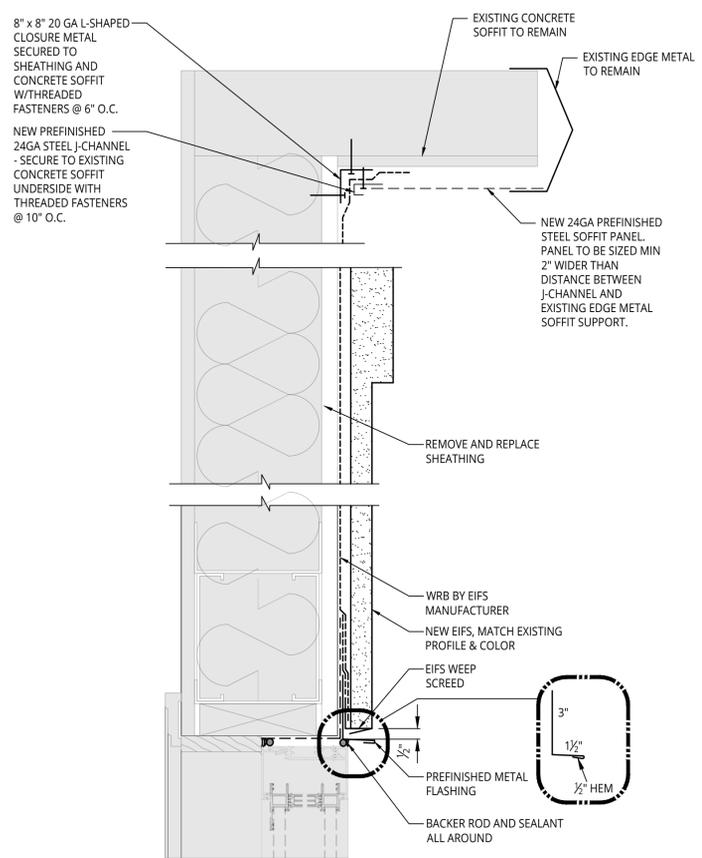

724B EIFS
NOT TO SCALE

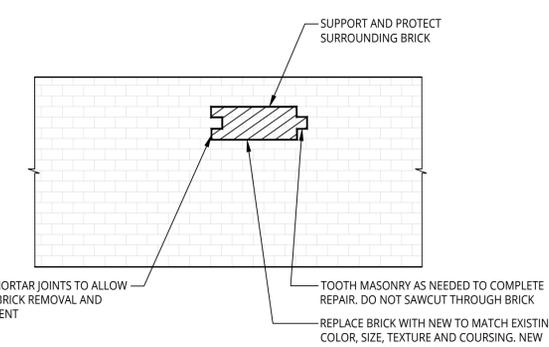

421 BRICK REPLACEMENT
NOT TO SCALE

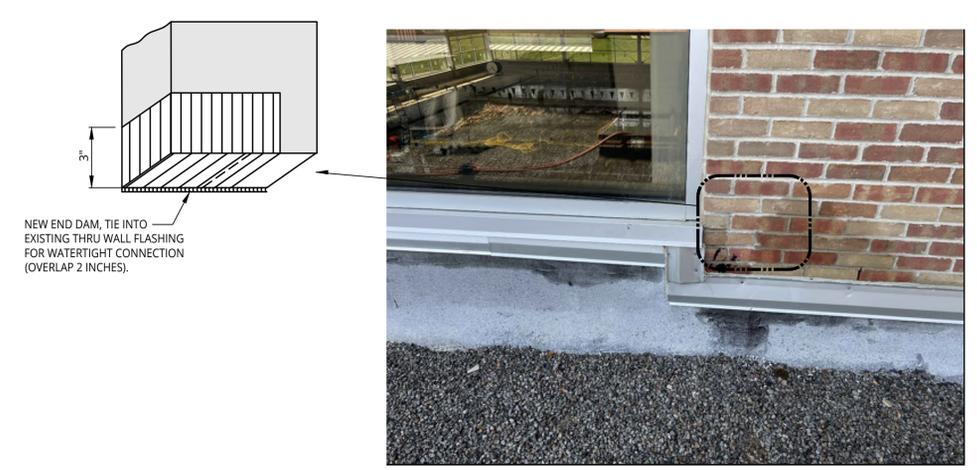

405E END DAM
NOT TO SCALE

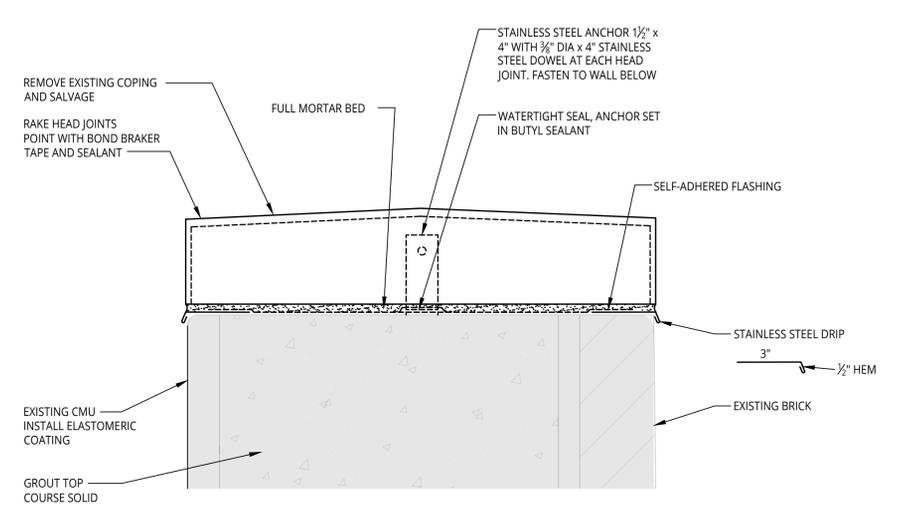

405D SCREEN WALL FLASHING
NOT TO SCALE

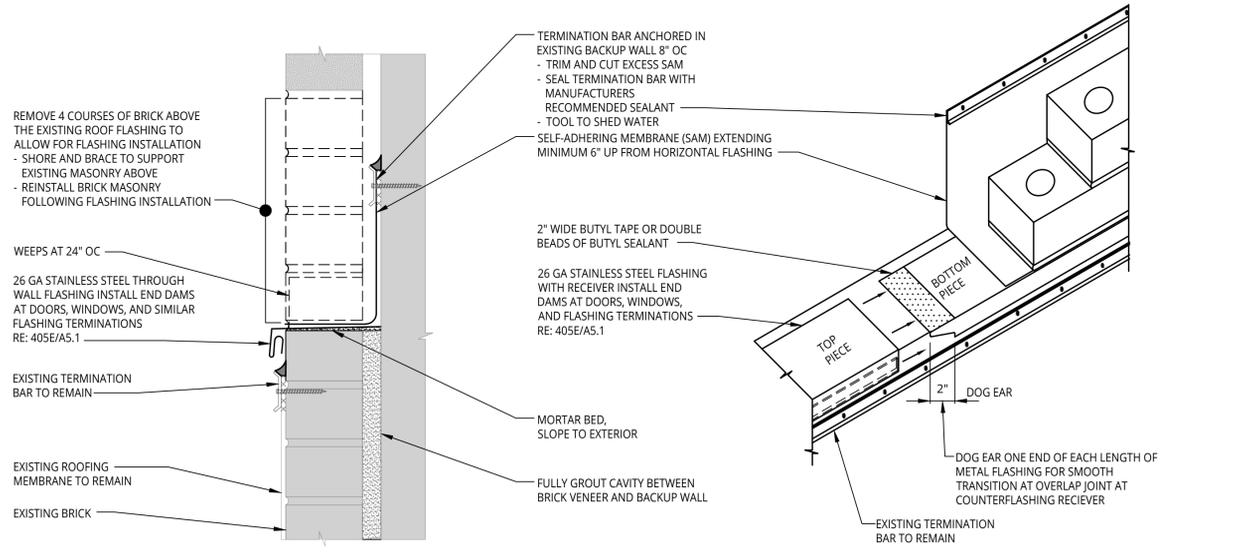

405C THROUGH WALL FLASHING
NOT TO SCALE



405B GRIND HORIZONTAL REINFORCING & REPOINT
NOT TO SCALE

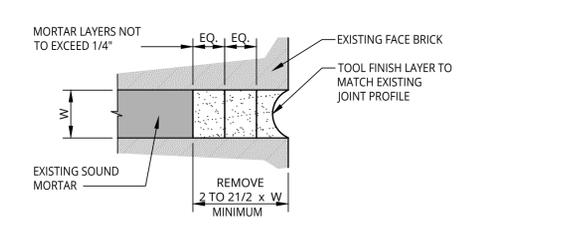

405A REPOINTING
NOT TO SCALE

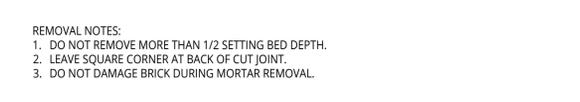

405A REPOINTING
NOT TO SCALE

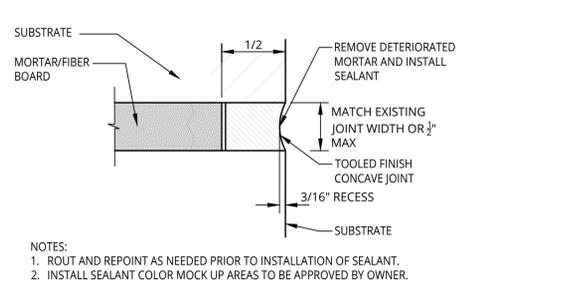

401 742 792B ROUT AND SEALED JOINT
NOT TO SCALE

J:\sme-inc\p\w\p\091744.00\CAD\Design Files\MAT\BIDS 1-16-24\091744-00-DETAILS.dwg
PLOT DATE: Jun 09, 2024 - 7:24am - by:ayna.kuznetsov

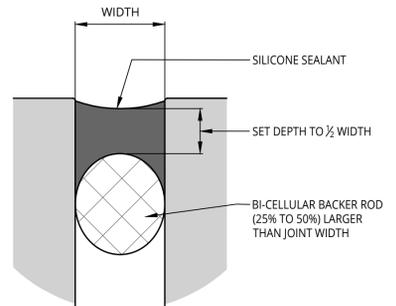

792B 792D 792F 795 BUTT / PERIMETER SEALANT JOINT
NOT TO SCALE

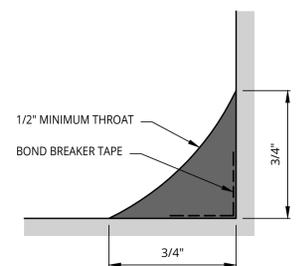

792A FILLET / COVE SEALANT JOINT
NOT TO SCALE

- CUT OFF GASKET FLANGE.
- INSTALL BOND BRAKER TAPE.
- INSTALL SEALANT S-1 FILLET JOINT ALL AROUND.

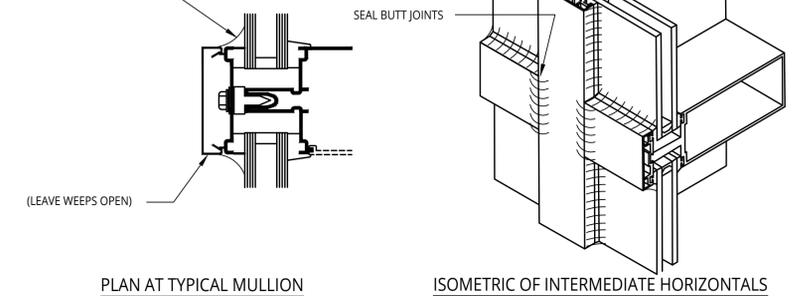

792C NEEDLE GLAZING
NOT TO SCALE

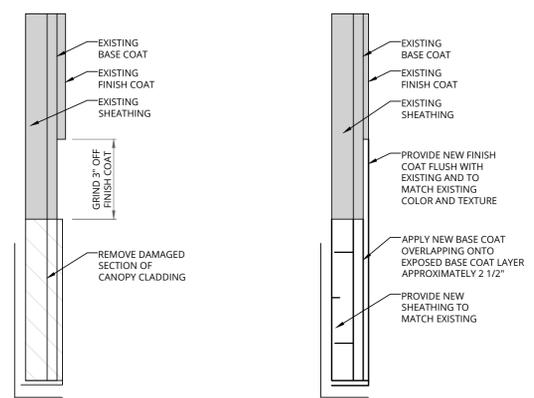

724 CANOPY PATCH
NOT TO SCALE

PATCH STEP 1

PATCH STEP 2

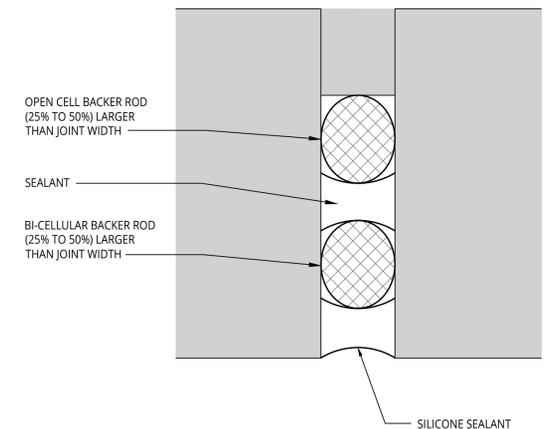

792E SEALANT CONTROL JOINT AT PRECAST CONCRETE
NOT TO SCALE

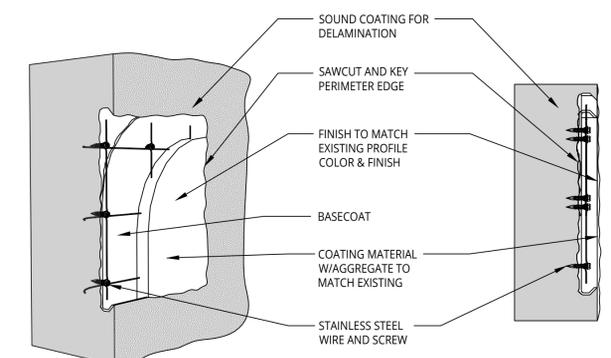

744 AGGREGATE COATING REPAIR
NOT TO SCALE

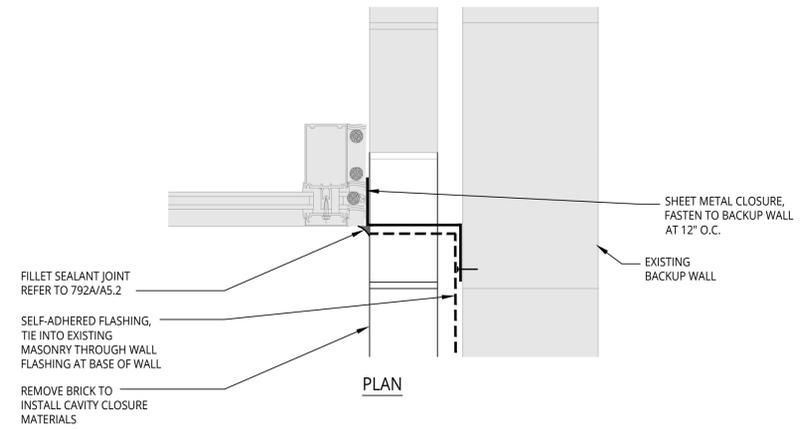

405F FULL HEIGHT END DAM
NOT TO SCALE



Project
WATERFORD SCHOOL DISTRICT BUILDING ENCLOSURE REPAIRS - 4 BUILDINGS

Project Location
WATERFORD TWP, MI

Sheet Name
DETAILS

Seal

Revisions

OWNER REVIEW	12/22/23	TM
BID	1/16/24	KMD

SME Project No.
091744.00

Project Manager:
AKC

Designer:
AKC

CADD:
BK

Checked By:
AKC

Reviewed By:
JT

Sheet No.
A5.2

DRAWING NOTE: SCALE INDICATED IS MEANT FOR 24" X 36" AND WILL SCALE INCORRECTLY IF PRINTED ON ANY OTHER SIZE MEDIA
NO REPRODUCTION SHALL BE MADE WITHOUT THE PRIOR CONSENT OF SME
© 2024